

The Mesa Series is a single phase, standby, solid-state inverter system designed to provide "soft-start" power to designated emergency lighting fixtures. Each system consists of a self-contained inverter section with a fully automatic, thermal-compensating, variable-rate battery charger. The Mesa series is designed to function in conjunction with the existing building electrical system to provide Pulse Width Modulated (PWM), sinusoidal, high-quality power conditioning, backup power protection and distribution for lighting loads and other critical loads. Upon failure of the normal utility power, the Mesa Series automatically transfers to inverter mode and provides a minimum of 90 minutes of emergency power to the connected load. Lumen output will be maintained at 100% of the lamp's rating throughout the duration.

Model: \_\_\_\_\_ Date: \_\_\_\_\_  
Accessories: \_\_\_\_\_  
Job Name: \_\_\_\_\_ Type: \_\_\_\_\_

**SPECIFICATIONS**

- Standard Power Level:** 375 or 600 Watts
- Power Factor Range:** 0.88 leading to 0.88 lagging
- Input Voltage:** Universal user-selectable 120 or 277VAC
- Input Frequencies:** 60Hz +/- 2%
- Output Voltage:** 120 or 277VAC single phase (must match input)
- Output Frequencies:** 60 Hz, ±3% during emergency cycle
- Efficiency:** ≥98% at 100% linear load
- Waveform:** Sinusoidal (digitally controlled)
- Output Distortion:** <3% THD @ 100% linear load
- Transfer Time:** <1.0 second
- Input Protection:** Service panel rated at 20 amps maximum
- Output Protection:** Output Main Circuit Breaker
- Surge Protection:** Conforms to UL924 standards
- Battery:** Sealed Lead Calcium (10 year life)
- Battery Voltage:** 60/96VDC for 375/600W respectively
- Battery Protection:** Low Voltage Disconnect and AC Lockout
- Other Protection:** Brownout protection; Reverse polarity, DC overload and short circuit protection by DC input breaker and fuse
- Charger Type:** Fully automatic, temperature compensated, dual mode charger
- Recharge Cycle:** Conforms to UL924 Standards
- Control:** Momentary test switch, AC-on, Charge-on and Inverter-on LED indicator lights
- Operating Temperature:** 20° to 30°C (68° to 86°F)
- Power Consumption:** 37W maximum (2.5W in standby) for 375W  
56W maximum (5W in standby) for 600W
- Warranty:** Any component that fails due to a manufacturing defect is guaranteed for five years with a separate 10 year prorated warranty on the battery. The warranty does not cover physical damage, abuse or instances of uncontrollable natural forces. See the full Exitronix warranty document for detailed information. (Terms and Conditions Apply)



**ORDERING INFORMATION** Example: MSA-375-G2

Series	Power Capacity	Options
MSA	375 = 375W	AO = Adjustable Output (4 levels) with 4 output circuits
	600 = 600W	CB = (2) 10A Output Circuit Breakers
		G2 = Self-testing/Self-diagnostics

Specifications are subject to change without notice. Installation must be performed in accordance with Barron Lighting Group installation instructions.

Series	Input/Output Voltage	Capacity For 1½ Hours (Watts/VA)	System Weight		System Efficiency (Full Load)	Number of Batteries	Battery Voltage (VDC)	Battery Current (Amps)	AC Input Current (Max)		Thermal Output (BTUs)	
			LBS	KG					120VAC	277VAC	On-Line	Emergency
MSA-375	120/277VAC	375/375	113	51.3	98%	5	60	7.3	3.4	1.5	11	205
MSA-600	120/277VAC	600/600	172	78.1	98%	8	96	7.1	5.5	2.4	15	275

### POWER RATING

375 or 600 Watt single phase output unit uses the latest technology to provide the most advanced performance and reliability features.

### INPUT/OUTPUT

120/120VAC or 277/277VAC input/output

#### AC Input Characteristics

- Input Frequency: 60 Hz +/- 2%
- Soft start power walk-in design reduces fixture inrush current eliminating compatibility problems with LED drivers as well as fluorescent and induction ballasts: 0-100% over a 10-second period
- Accommodates up to 12AWG wire
- Surge Protection: Conforms to UL 924 Standards

#### AC Output Characteristics

- Voltage Regulation: +/- 5% during battery discharge. 0-100% linear load
- Stand-by design is ≥98% efficient at 100% linear load
- Frequency: 60 Hz (+/- 0.3Hz during emergency cycle)
- Voltage Distortion: <3% THD @ 100% linear loads
- Load Power Factor Range: 0.88 Lead to 0.88 Lag
- Outut Protection: Circuit Breaker, short circuit and overload protection
- Transfer to inverter mode within one (1) second

### BATTERIES

The Mesa Series inverter employs a sealed, lead-calcium, heavy duty, industrial battery system with 60VDC for the MSA-375 model or a 96VDC for the MSA-600 model designed for auxiliary power service.

- The Mesa Series inverter is equipped with a low voltage battery disconnect circuit to protect the battery from being severely damaged by deep discharges during prolonged power failures
- The Mesa Series inverter is equipped with a DC input breaker to protect against DC overload and short circuit
- Reverse polarity battery protection is included
- Three (3) years full with seven (7) additional prorated year warranty
- Runtime: 90 minutes standard based on battery performance at 25°C (77°F)
- Charger consists of a fully automatic, temperature compensated, dual-mode charger with a power consumption of 37W maximum (2.5W in standby) for MSA-375 model and 56W maximum (5W in standby) for MSA-600 model
- Recharge duty cycle conforms to UL924 standards
- AC lockout prevents battery discharge prior to initial unit power up

### LAMPS AND LOADS

- Pure sine wave output for all types of lamps
- Emergency power provides FULL LIGHT OUTPUT from all lamps and fixtures for the entire runtime
- Standard or LED Exits and other safety equipment
- Standard or electronic ballasts, dimming devices or panels, sensors and most control equipment
- Operates fluorescent, incandescent, quartz, LED and other lamp types
- Emergency fixtures can be ON, OFF, SWITCHED, or on TIMER

### OPTIONAL ADJUSTABLE OUTPUT (Option: AO)

Allows dimmable LED fixtures with 0-10V drivers to be connected to and powered by the Mesa inverter.

- In emergency mode, four (4) independent output circuits disconnect the load side of the local dimmer control, and connect the selected loads to the Mesa output(s)
- All four emergency circuits are user-programmable to operate the connected fixtures at approximately 25%, 50%, 75%, or 100% of the nominal output during power outages
- Each override circuit is controlled by DIP switches which determine the emergency output level (see AO wiring diagram)

### PROTECTION

- A solid state low voltage disconnect circuit is used to protect the battery from being severely damaged by a deep discharge
- A brownout sensing circuit insures proper operation during 'low-line' conditions. Unit will automatically transfer to emergency power when utility power drops to a point that would cause fluorescent lamps to extinguish
- Overload and short circuit protection provided
- Transfer in less than one (1) second

### SYSTEM STATUS

The Mesa Series Inverter design provides a monitoring panel on the front of the unit to show operating status at all times. The panel provides a manual test switch for users to initiate system tests and a 3-LED array indicating system status. Lights show status for AC-ON (red), Charge-ON (green), and Inverter-ON (amber).



### OPTIONAL SELF-DIAGNOSTICS (Option: G2)

Provides visual indication for battery, charger and load faults. Conducts automatic 30-second battery discharge test every 30 days, a 30-minute test every 6 months, and a 90-minute test once a year. Test switch allows for manual initiation of a 30-second, a 30-minute or a 90-minute system test. For Self-test/Self-diagnostics models the lights show status for Normal Mode (steady green), Test-mode (blinking green), High Charge (blinking red/green), Inverter-ON (amber).

### OPTIONAL OUTPUT CIRCUIT BREAKER (Option: CB)

Standard models are not supplied with output circuit breakers. This option supplies two (2) 10A circuit breakers to protect output loads.

### CODES

- Complies with the Buy American Act (Level 3)
- The Mesa Series shall meet the requirements of the following standards:
  - IEEE 587-1980/ANSI C62.41 1980 Standards for Surge Withstand Ability
  - FCC rules and regulations of Part 15, Subpart J, Class A
  - Meets UL 1778, UL 924 Damp Location, Standards for Lighting Inverter Equipment
  - NFPA 101 Life Safety Code
  - NFPA 70 National Electrical Code
  - OSHA - Occupational Safety & Health Administration
  - Certified to CEC under Title 20 Regulations

### CABINET

- Space saving small footprint with a modular design enabling flexible installation
- Enclosure: The Mesa Series cabinet is made of heavy duty steel finished in white baked-on powder paint providing scratch resistance. The Mesa Series inverter system's sinusoidal AC output design eliminates voltage drop and proximity concerns allowing added flexibility in installation location as Mesa units can be installed hundreds of feet from the units they power. This means the Mesa units can be located conveniently out of sight in closets or utility rooms without interrupting architectural aesthetics. In lighting applications, no special or additional emergency fixtures are necessary. Simply designate and connect existing light fixtures, either interior or exterior, to the Mesa inverter for emergency operation eliminating the need for exposed, stand-alone emergency luminaires

## INSTALLATION

- The Mesa Series is designed for surface mounting to walls by means of keyhole slots provided in the back of the unit housing
- Unit may be installed up to 1000 feet from controlled fixture(s) that are Normally-ON and/or Normally-OFF in accordance with wiring diagrams
- Emergency fixtures can be ON, OFF or SWITCHED
- The Mesa Series has provisions for local switching capability, but will always remain on during emergency conditions regardless of local switch position
- I/O connectors will accommodate up to 12AWG wire
- The Mesa Series will operate under the following environmental conditions:
  - Operating Temperature: 20° to 30°C (68°F to 86°F)
  - Relative humidity (operating and storage): 5 to 95% non-condensing
  - High Altitude Operation: Maximum operating temperature drops 1 degree C per 300 meters (2 degrees F per 1000 feet) above sea level

## DELIVERY, STORAGE, AND HANDLING

- All products are packaged in a manner to prevent penetration by debris and to allow safe delivery by all modes of ground transportation and air transportation where specified
- Prior to shipping all products are inspected at the factory for damage
- Equipment is protected against extreme temperature and humidity and is stored in a conditioned or protected environment
- Equipment containing batteries will not be stored for a period exceeding three months without powering up the equipment for a period of eight hours to recharge the batteries

## WARRANTY

- Three (3) year full warranty from date of shipment against defects in materials and workmanship (excluding lamps)
- Battery warranty 3 year with an additional 7 years pro-rated

## DIMENSIONS

MSA-375

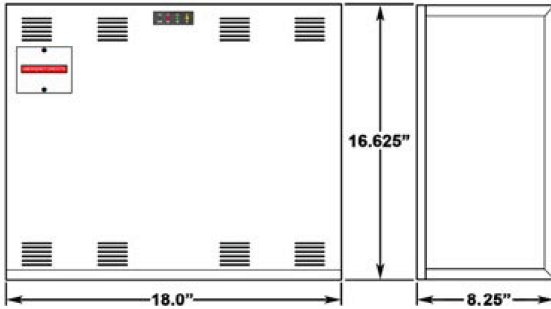

MSA-600

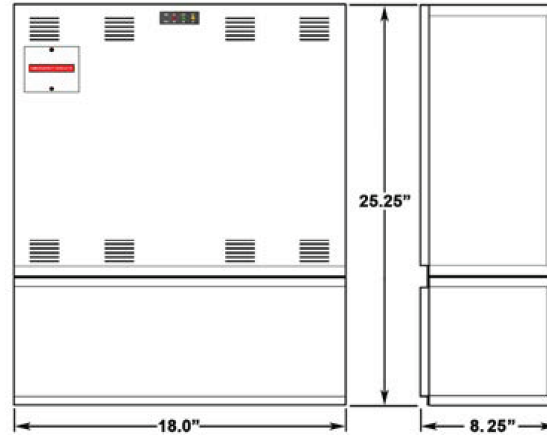

SEE PAGE 4 FOR WIRING DIAGRAMS

WIRING DIAGRAMS

NORMALLY ON LOADS

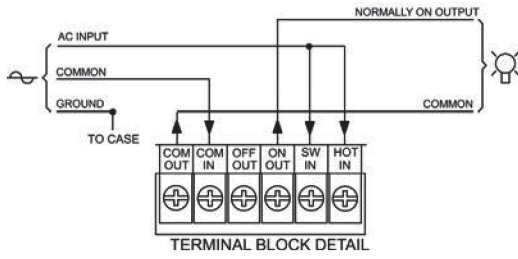

NORMALLY OFF LOADS

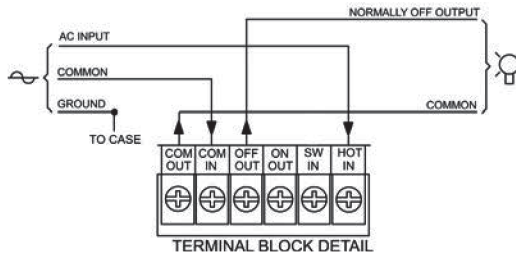

NORMALLY ON & OFF LOADS

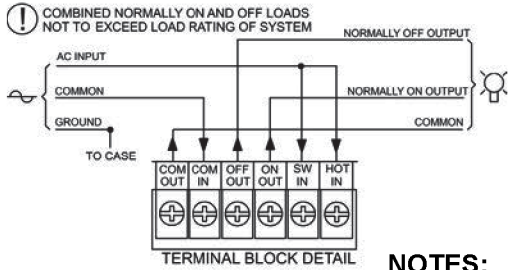

SWITCHED LOADS

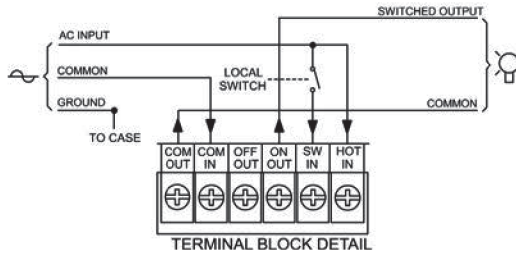

NOTES:

- INPUT SUPPLY FROM UNSWITCHED UTILITY RATED 20 AMPS MAXIMUM.
- OUTPUT(S) TO LIGHTING LOADS

VOLTAGE SELECTION DETAIL

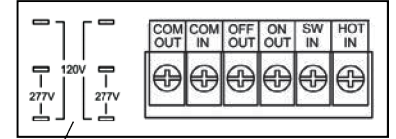

NOTE:

Factory terminated jumper wires are provided with the MSA systems for making user selected input/output voltage connections.

WIRING DIAGRAMS FOR ADJUSTABLE OUTPUT (OPTION: AO)

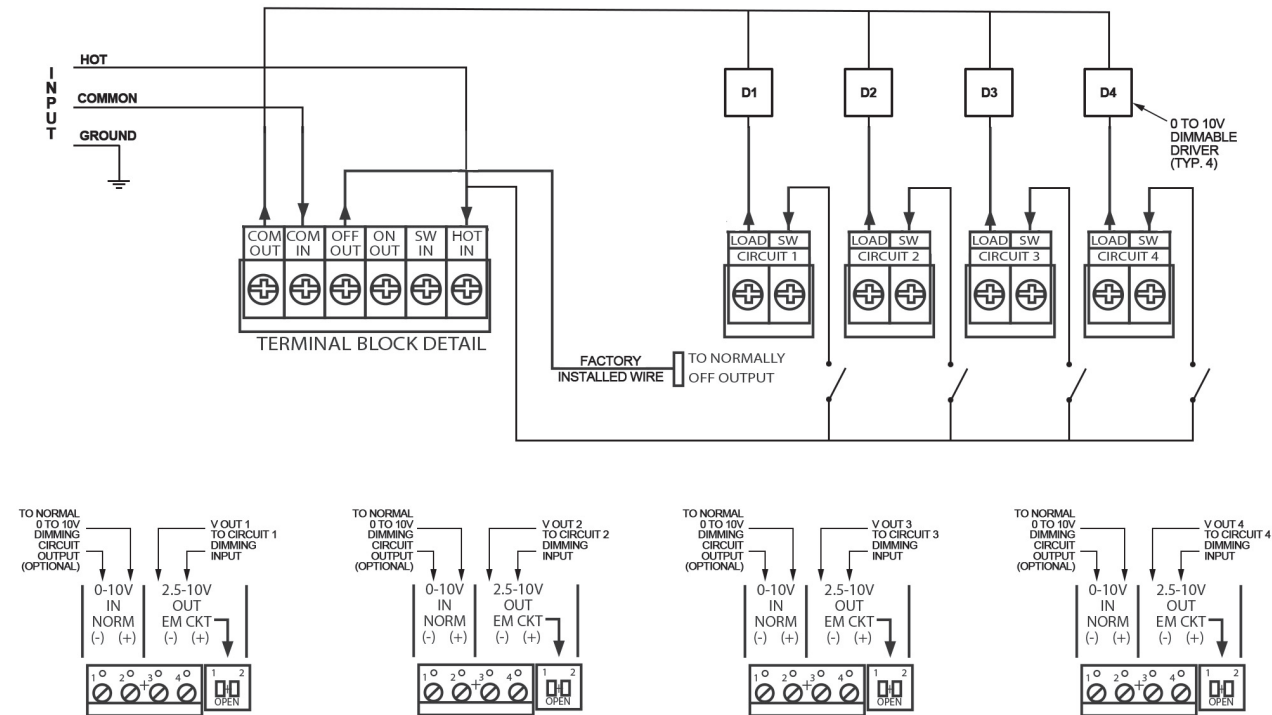

Specifications are subject to change without notice. Installation must be performed in accordance with Barron Lighting Group installation instructions.