

The 400C Series is the very first LED die-cast aluminum exit/emergency combo unit available, combining an appealing design, the latest in die cast technology, and high performance electronics to ensure reliability.

Model: _____ Date: _____
Accessories: _____
Job Name: _____ Type: _____

FEATURES & BENEFITS

- Unique design, LED die-cast combo provides a spec-grade, low profile exit sign with LED emergency lights using only 3W per lamp
- Maintenance-free NiCad battery
- Ceiling, wall or end mount
- UL Listed 90 minute emergency run time, 24 hour recharge time
- Field selectable directional chevron knockouts
- California Energy Commission (CEC) compliant
- Suitable for Damp Location



SPECIFICATIONS

Illumination: High-intensity red or green LED legend with fully adjustable 3W LED emergency lamps

Housing: Die-cast aluminum

Input: 120/277VAC Dual Primary, 60Hz

Battery: Maintenance-free NiCad battery

Operating Temp: 0°C to 40°C (32°F to 104°F)

Run Time: UL Listed 90 minute emergency run time, 24 hour recharge time

Mounting: Ceiling, end or wall mount, mounting canopy included

Finishes: Brushed Aluminum, Black or White

Certifications: UL 924 Listed, meets or exceeds NEC requirements and NFPA 101

Warranty: Any component that fails due to a manufacturing defect is guaranteed for five years with a separate five year prorated warranty on the battery. The warranty does not cover physical damage, abuse or instances of uncontrollable natural forces. See the full Exitronix warranty document for detailed information.

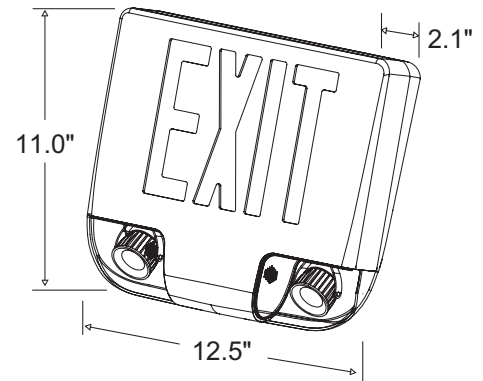

ORDERING INFORMATION Example: 400C-1-BA

Series	Face	Finish	Accessories ² (Field Installed)
400C = Red LEDs	1 = Single-face	BA = Brushed Alum. w/ Alum. Face	WG-S = Wire Guard (Back Mount)
G400C = Green LEDs	2 = Double-face	BB = Black w/ Black Face	XG-6 = Poly Guard (Back Mount)
		BL = Black w/ Alum. Face	ER1-Kit ¹ = Pendant Mount Kit
		WW = White w/ White Face	ER2-Kit ¹ = Pendant Mount Kit
Notes			VEPA = Pendant Adaptor

¹ Requires VEPA option

² Order as separate line item

CONSTRUCTION

The Exitronix 400C is constructed of a rugged die-cast aluminum body with soft corners (designed for traditional mounting as well as conduit entry and pendant mounting). Clear finish on brushed face prevents fingerprints or other surface impurities. Field-selectable chevron knockouts are concealed and easily removed. All units are supplied with mounting canopy for ceiling, end or wall mounting.

ILLUMINATION

Illumination is accomplished utilizing high-intensity, long-life LEDs exceeding UL 924 requirements for brightness and uniformity, while maximizing energy efficiency.

ELECTRICAL

Input

Dual-voltage input 120/277VAC @ 60Hz.

Nickel Cadmium Battery - NiCad

Exitronix nickel cadmium batteries are maintenance-free with a life expectancy of 15 years. Nickel cadmium batteries offer high discharge rates and continue to perform in a vast temperature range from 0°C to 40°C (32°F to 104°F).

Solid-State Transfer

The circuit features solid-state switching for emergency lamps, eliminating concerns of damaged contact or mechanical failures associated with relays. The switching circuit detects a loss of line voltage and automatically switches to emergency mode.

Brownout Circuit

Brownout circuit monitors the line voltage, as the line voltage sags and can no longer illuminate the exit sign to meet UL 924 visibility test; the emergency circuit will turn on to supply a portion or all the power to illuminate the sign for a minimum of 90mins until the line voltage is restored.

Test Button

The test button is easy to locate and provides manual verification of the transfer circuit and emergency lamps.

INSTALLATION

Installs in minutes with easy-to-read instructions and detailed diagrams. No special hardware or tools necessary. Internally housed components and battery eliminate the risk of damage during installation. Mounting canopy included.

CONFORMANCE TO CODES & STANDARDS

The 400C Series is UL 924 listed and meets or exceeds the following: CEC, NEC requirements and NFPA 101.

SAMPLE PHOTOMETRICS

Using multiple units mounted at a typical 7.17' delivers 16' center-to-center spacing on a 3' wide egress path.

